

Operator's Guide

Thank you for purchasing this liquid crystal projector.



CAUTION • Please read the “Product Safety Guide” and this “Operator's Guide” thoroughly to ensure correct usage through understanding. After reading, store this instruction manual in a safe place for future reference.

NOTE

- The information in this manual is subject to change without notice.
- The manufacturer assumes no responsibility for any errors that may appear in this manual
- The reproduction, transmission or use of this document or contents is not permitted without express written authority.

TRADEMARK ACKNOWLEDGMENT : PS/2, VGA and XGA are registered trademarks of International Business Machines Corporation. Apple, Mac and ADB are registered trademarks of Apple Computer, Inc. VESA and SVGA are trademarks of the Video Electronics Standard Association. Windows is a registered trademark of Microsoft Corporation. Carefully observe the trademarks and registered trademarks of all companies, even when not mentioned.

CONTENTS

	Page		Page
FEATURES	2	TROUBLESHOOTING	20
BEFORE USE	2	OSD Message	20
Contents of Package	2	Indicators Message	21
Part Names.....	3	Symptom	22
Loading the Batteries.....	5	SPECIFICATIONS	23
INSTALLATION	6	ACCESSORIES	24
Installation of the Projector and Screen.....	6	
Angle Adjustment	6	TABLES	
Cabling	7	Table 1. Installation Reference.....	6
Power Connection	8	Table 2. Cabling	7
Example of System Setup	8	Table 3. Basic Operation	10
Plug & Play	8	Table 4. Setup Menu	12
OPERATIONS	9	Table 5. Input Menu.....	13
Power ON	9	Table 6. Image Menu.....	14
Power OFF	9	Table 7. Options Menu	15
Basic Operation	10	Table 8. No Signal Menu	16
Setup Menu	12	Table 9. OSD Message	20
Input Menu.....	13	Table 10. Indicators Message	21
Image Menu.....	14	Table 11. Symptom	22
Options Menu	15	Table 12. Specifications	23
No Signal Menu	16	
MAINTENANCE	17	For "TECHNICAL" , see the end of this	
Lamp.....	17	manual.	
Air Filter	19		
Other Maintenance	19		

FEATURES

This liquid crystal projector is used to project various computer signals as well as NTSC / PAL / SECAM video signals onto a screen. Little space is required for installation and large images can easily be realized.

Outstanding Brightness

The UHB lamp and high-efficiency optical system assure a high level of brightness.

Partial Magnification Function

Interesting parts of images can be magnified for closer viewing.

Distortion Correction Function

Distortion-free images are quickly available.

Extra-low Noise Function

Acoustic noise level from the unit can be reduced.

BEFORE USE

Contents of Package

Make sure all of the following items are included in the package. If anything is missing, please contact your dealer.

NOTE • Keep the original packing material for future reshipment.

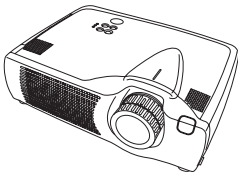

Projector



**Power Cord
(US, UK, Europe)**



**S-Video
Cable**

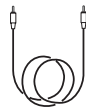

Stereo Mini-Cable

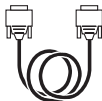

VGA Cable

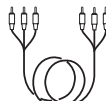

**Video/Audio
Cable
(with white lead)**



**Component Video
Cable
(with green lead)**

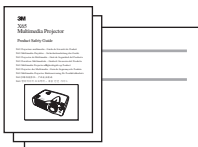

**Operator's Guide
Product Safety Guide
Warranty
Quick Start Guide**

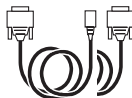

**Mouse Cable
(PS/2, Serial)**



**Batteries
for Remote Control
Transmitter**



**Remote Control
Transmitter**

BEFORE USE (continued)

Part Names

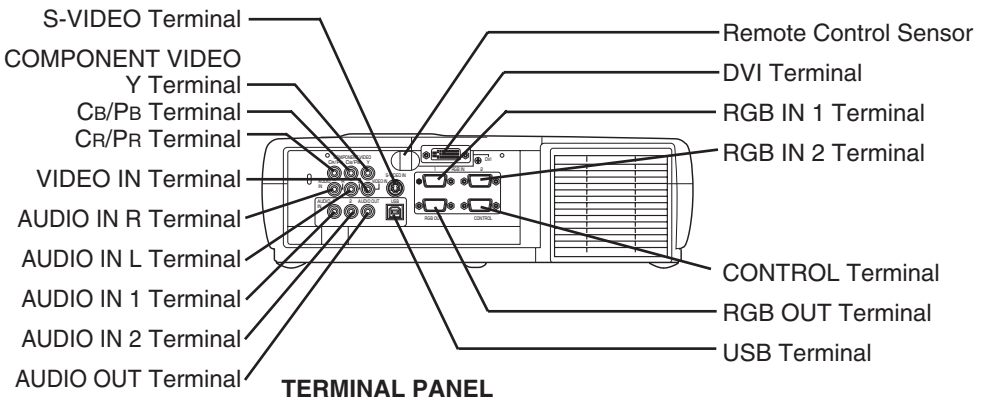
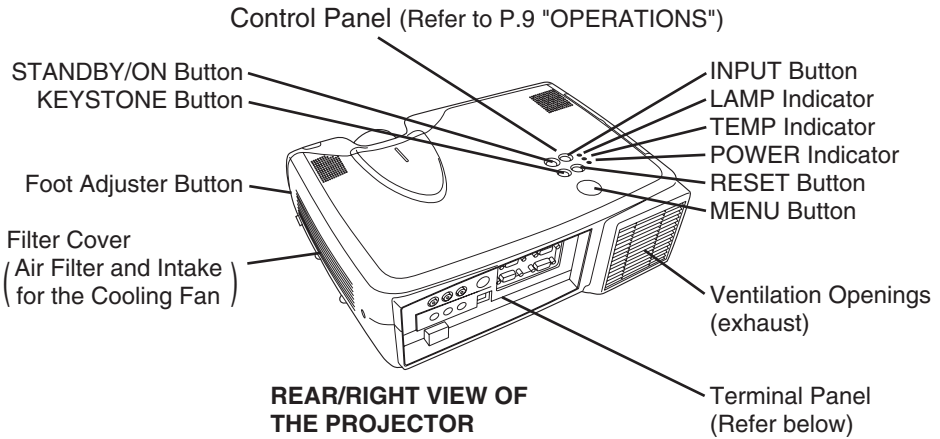
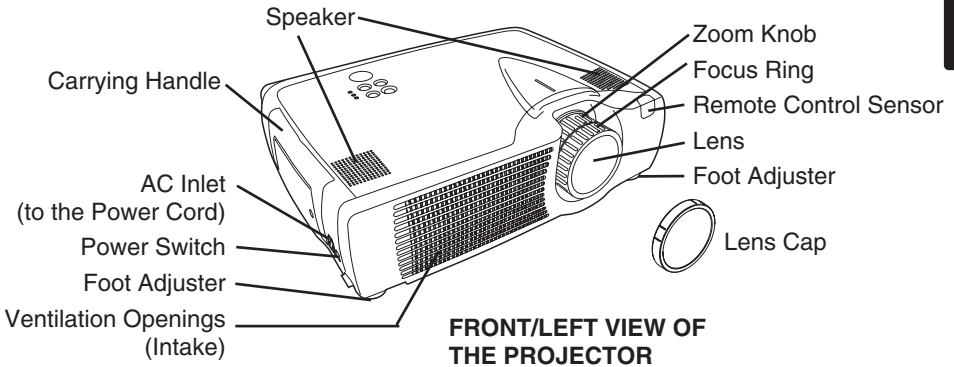

BEFORE USE (continued)

Part Names (continued)

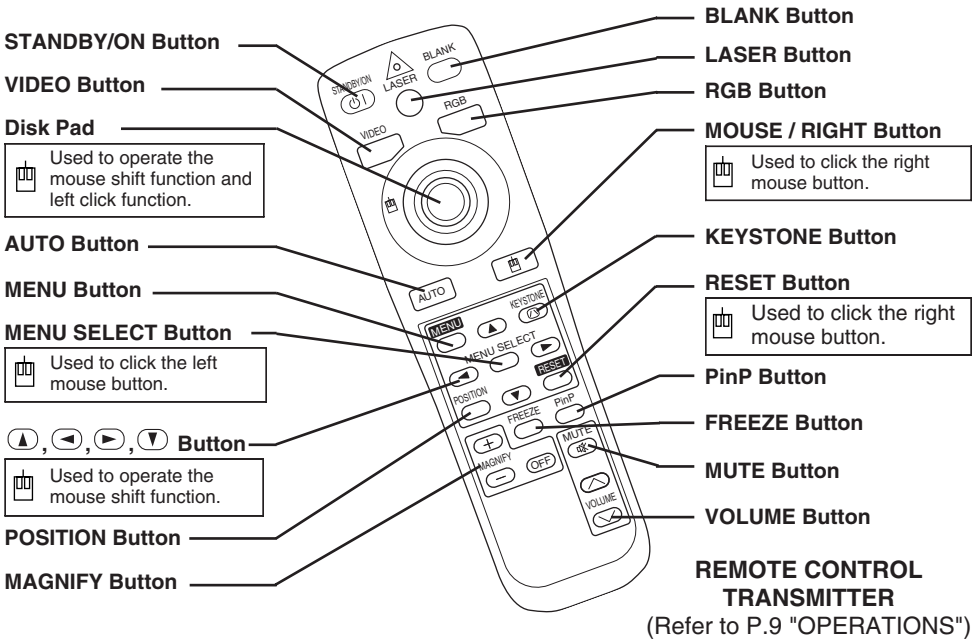

These functions work when the mouse control function is activated. Remember, the POSITION, BLANK ON and MENU ON functions disable the mouse control function.

- WARNING** • The laser pointer of the remote control transmitter is used in place of a finger or rod. Never look directly into the laser beam outlet or point the laser beam at other people. The laser beam can cause vision problems.
- CAUTION** • Use of controls or adjustments or performance of procedures other than those specified herein may result in hazardous radiation exposure.

AVOID EXPOSURE-
LASER RADIATIONS IS
EMITTED FROM THIS
APERTURE

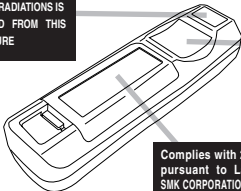

CAUTION
LASER RADIATION:
DO NOT STARE INTO BEAM!
MAX. OUTPUT: 1mW
WAVE LENGTH: 650nm
CLASS II LASER PRODUCT

LASER RADIATION:
DO NOT STARE INTO BEAM!
CLASS II LASER PRODUCT
MAX. OUTPUT: 1mW
WAVE LENGTH: 650nm
©2008/11 11993-A1-1997



Complies with 21 CFR 1040.10 and 1040.11 except for deviations pursuant to Laser Notice No.50, dated 2001.7.26
SHIKI CORPORATION
6-5-5 Togo-shi Shinagawa-ku, Tokyo, JAPAN 142-8511
MANUFACTURED November 2001
PLACE OF MANUFACTURER: A

NOTE • Keep the remote control transmitter away from children and pets.

- Do not give the remote control transmitter any physical impact. Take care not to drop.
- Do not place the heavy objects on the remote control transmitter.
- Do not wet the remote control transmitter or place it on any wet object.
- Do not place the remote control transmitter close to the cooling fan of the projector.
- Do not disassemble the remote control transmitter.

BEFORE USE (continued)

Loading the Batteries

Install the AA batteries into the remote control transmitter.

1. Remove the battery cover.
Push the knob while lifting up the battery cover.
2. Load the batteries.
Make sure the plus and minus poles are correctly oriented.
3. Close the battery cover.

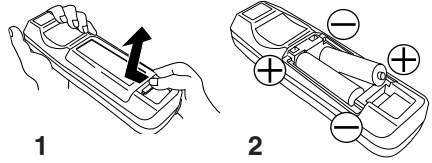

CAUTION • Use only the specified batteries with this remote control transmitter. Also, do not mix new and old batteries. This could cause battery cracking or leakage, which could result in fire or personal injury.

- When loading the batteries, make sure the plus and minus terminals are correctly oriented as indicated in the remote control transmitter. Incorrect orientation could cause battery cracking or leakage, which could result in personal injury or pollution of the surrounding environment.
- When you dispose the battery, you should obey the law in the relative area or country.
- Keep the battery away from children and pets.
- When not to be used for an extended period, remove the batteries from the remote control transmitter.

NOTE Replace the batteries when remote control transmitter operation becomes difficult.

INSTALLATION

Installation of the Projector and Screen

Refer to the drawing and table below for determining the screen size and projection distance.

The projection distances shown in the table below are for full size (1024 x 768 dots).

a: Distance from the projector to the screen. ($\pm 10\%$)

Table 1. Installation Reference

Screen size [inches (m)]	a [inches (m)]	
	Min.	Max.
40 (1.0)	62 (1.6)	82 (2.1)
60 (1.5)	94 (2.4)	123 (3.1)
80 (2.0)	127 (3.2)	164 (4.2)
100 (2.5)	160 (4.1)	205 (5.2)
120 (3.0)	192 (4.9)	246 (6.3)
150 (3.8)	241 (6.1)	308 (7.8)
200 (5.0)	323 (8.2)	411 (10.4)

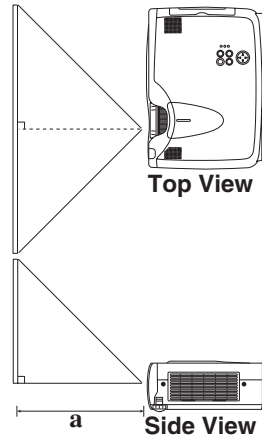

CAUTION • Install the projector in a suitable environment according to instructions of the “Product Safety Guide” and this manual.

- When you attach this unit to a metal mount you must properly ground the fixture; otherwise, fire or electrical shock can result.

Connect the ground terminal of AC inlet of this unit with the ground terminal provided at the building using an optional three-core power-supply cord.

- Please basically use liquid crystal projector at the horizontal position. If you use liquid crystal projector by the lens up position, the lens down position and the side up position, this may cause the heat inside to build up and cause damage. Be especially careful not to install it with ventilation holes blocked.
- Do not install LCD projector in smoke effected environment. Smoke residue may buildup on critical parts (i.e.LCD panel, Lens Assy etc.).

Angle Adjustment

Use the foot adjusters on the bottom of the projector to adjust the projection angle. It is variable within 0° to 9° approximately.

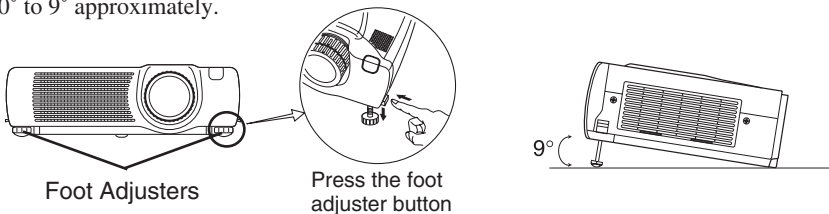

1. Lift up the front side of the projector, and pressing the foot adjuster button, adjust the projection angle.
2. Release the button to lock at the desired angle.
3. Use the foot adjusters for fine adjustment. Do not force the adjuster screws. This could damage the adjusters or cause the lock to fail.

CAUTION • Do not release the foot adjuster button unless the projector is being held; otherwise, the projector could overturn or fingers could get caught and cause personal injury.

INSTALLATION (continued)

Cabling

Refer to the table below for connecting each terminal of the projector to a device.

Table 2. Cabling

Function	Terminal	Cable
RGB input	RGB IN 1	VGA cable with D-sub 15-pin shrink jack and inch thread screws
	RGB IN 2	
RGB output	RGB OUT	
DVI input	DVI	DVI cable with inch thread screws
Audio input (from the computer)	AUDIO IN 1 (interlocked with RGB IN 1 or DVI)	Audio cable with stereo mini jack
	AUDIO IN 2 (interlocked with RGB IN 2)	
PS/2 mouse control	CONTROL	PS/2 mouse cable
ADB mouse control		ADB mouse cable
Serial mouse control		Serial mouse cable
RS-232C communication		RS-232C cable
USB mouse control	USB	USB cable
S-video input	S-VIDEO IN	S-video cable with mini DIN 4-pin jack
Video input	VIDEO IN	Video/Audio cable
Component video input	COMPONENT VIDEO Y	Component video cable
	COMPONENT VIDEO Cb/Pb	
	COMPONENT VIDEO Cr/Pr	
Audio input (from video equipment)	AUDIO IN L	Video/Audio cable or Audio cable with RCA jack
	AUDIO IN R	
Audio output	AUDIO OUT	Audio cable with stereo mini jack



CAUTION • Incorrect connecting could result in fire or electrical shock.

Please read this manual and the “Product Safety Guide”.

- Before connecting, turn off all devices to be connected. This is not needed for a USB device because USB is plug & play capable.
- The cables may have to be used with the core set to the projector side. Use the cables which are included with the projector or specified.

NOTE

- Before connecting, read instruction manuals of the devices to be connected, and make sure that the projector is compatible with the device.
- Secure the screws on the connectors and tighten.
- For some RGB input modes, the optional Mac adapter is necessary.
- To select the DVI input, the computer may need some settings. See the manuals of the computer for details.
- Some computers may have multiple display screen modes. Use of some of these modes will not be possible with this projector.
- Refer to the “TECHNICAL” section for the pin assignment of connectors and RS-232C communication data.
- When the DVI terminal is used, the RGB OUT terminal may not function.

INSTALLATION (continued)

Power Connection

Use the correct power cord depending on the power outlet to be used.

Connect the AC inlet of the projector to the power outlet firmly by the power cord.



CAUTION • Be careful in handling the power cord according to instructions of the "Product Safety Guide" and this manual.

• Connect the power cord firmly. Avoid using a loose, unsound outlet or failed contact.

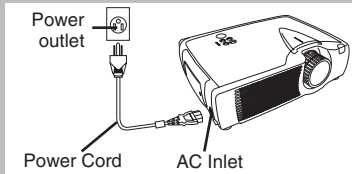

Example of Ssystem Setup

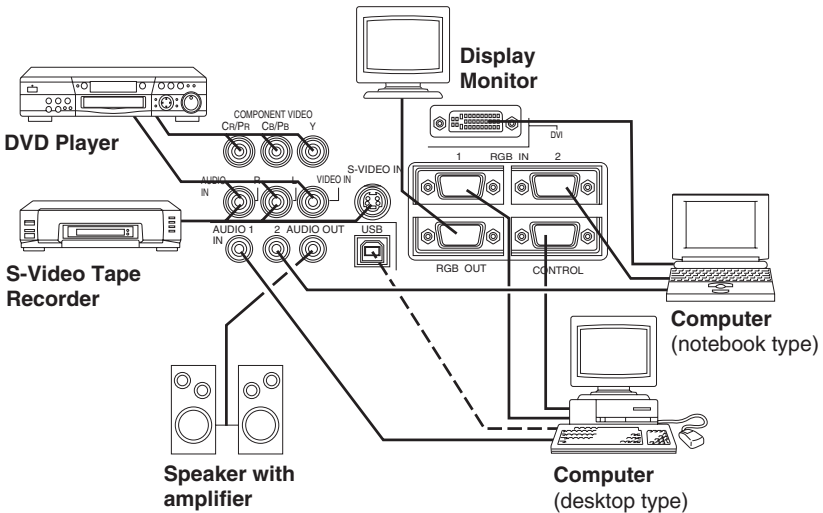

NOTE • When connecting with a notebook computer, set the proper RGB external image output (setting CRT display or simultaneous display of LCD and CRT). Please read instruction manual of the notebook for more information.

Plug & Play

This projector is VESA DDC 1/2B compatible. Plug & play is possible by connecting to a computer that is VESA DDC (Display Data Channel) compatible.

Please use this function by connecting the VGA cable with RGB IN 1 terminal (DDC 1/2B compatible), or by connecting a DVI cable with DVI terminal (DDC 2B compatible).

Plug & play may not operate by other connections.

NOTE • Plug & play is a system configured with peripheral equipment including a computer, display and an operating system.

• This projector is recognized as a plug & play monitor. Use the standard display drivers.

• Plug & play may not operate by the computer to connect. Use the RGB IN 2 terminal if plug & play does not operate correctly.

OPERATIONS

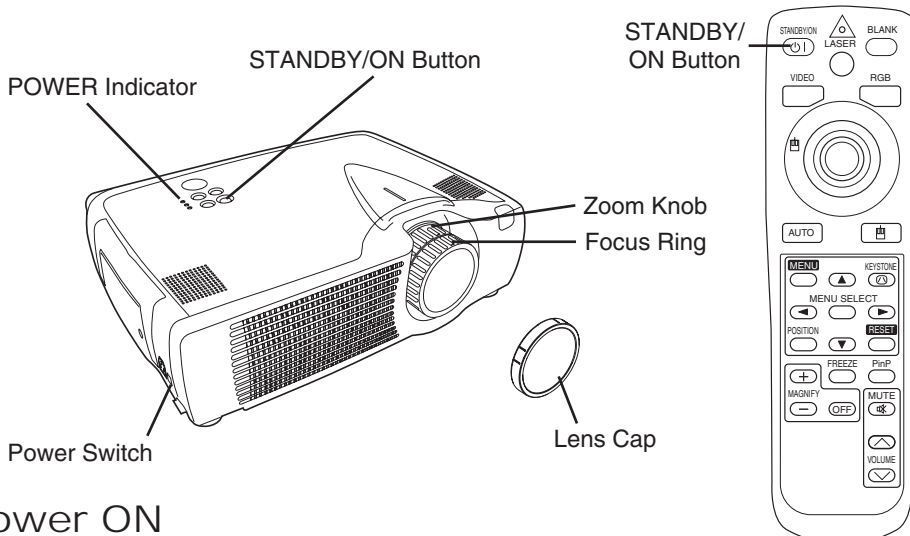

Power ON

1. Check that the power cord is connected correctly.
2. Set the power switch to [|]. The standby mode is selected, and the POWER indicator is turned to orange.
3. Press the STANDBY/ON button (⏻) on the control panel or the remote control transmitter. Warm-up begins and the POWER indicator blinks in green.
4. The POWER indicator ceases blinking and turns to green when power is on. Remove the lens cap.
5. Adjust picture size using the zoom knob.
6. Adjust focus using the focus ring .

Power OFF

1. Press the STANDBY/ON button (⏻) on the control panel or the remote controller. Then, the message "Power off?" will appear on the screen, and the message will disappear by any operation or no operation for 5 seconds. During this message indication, press the STANDBY/ON (⏻) button again. The projector lamp is extinguished and lamp cooling begins. The POWER indicator blinks orange during lamp cooling. Pressing the STANDBY/ON button (⏻) has no effect while the POWER indicator is blinking.
2. The system assumes the Standby mode when cooling is complete, and the POWER indicator ceases blinking and changes to orange. Check that the indicator is orange and set the power switch to [O].
3. The POWER indicator is extinguished when power is off. Do not forget to attach the lens cap.



WARNING • Please read this manual, and the "Product Safety Guide" thoroughly before using the equipment. Always ensure that the equipment is used safely.

- NOTE** • Except in emergencies, follow the above-mentioned procedure for turning power off. Incorrect procedure will reduce the life of the projector lamp and LCD panel.
- To prevent any trouble, turn on/off the projector when the computer or video tape recorder is OFF. Providing a RS-232C cable is connected, turn on the computer before the projector.
 - When a projector continues projecting the same image, the image may remain as an afterimage. Please do not project the image same for a long time.

OPERATIONS (continued)

Basic Operation

The basic operations shown in Table 3 is performed from the supplied remote control transmitter or the projector control panel. Items indicated by (*) may be used from the control panel.

Table 3 . Basic Operation

Item	Description
INPUT SELECT	<p>Select Input Signal (*) : Press the INPUT button. RGB IN 1→RGB IN 2→DVI→ VIDEO IN → S-VIDEO IN → COMPONENT VIDEO (→ RGB IN 1)</p> <p>Select RGB Input : Press the RGB button. VIDEO IN / S-VIDEO IN / COMPONENT VIDEO → RGB IN 1 / RGB IN 2 / DVI RGB IN 1 → RGB IN 2 → DVI (→ RGB IN 1)</p> <p>Select Video Input : Press the VIDEO button. RGB IN 1 / RGB IN 2 / DVI → VIDEO IN / S-VIDEO IN / COMPONENT VIDEO VIDEO IN → S-VIDEO IN → COMPONENT VIDEO (→ VIDEO IN)</p> <ul style="list-style-type: none"> • The selected signal name is displayed for approximately 3 seconds when the input signal is changed.
POSITION	<p>Set/Clear Position Adjustment Mode : Press the POSITION button. The [] icon is displayed in the POSITION mode.</p> <p>Image Position Adjustment: Press the ◀, ▶, ▲ and ▼ buttons in the POSITION mode.</p> <ul style="list-style-type: none"> • Valid only in the MAGNIFY mode with a video signal is input. • After approximately 10 seconds of inactivity the [] icon is extinguished and the POSITION mode is cleared automatically. • ◀, ▶, ▲ and ▼ buttons may operate as the mouse control button. Refer to page 4.
RESET (*)	<p>Initialize Each Item : Select an item and press the RESET button.</p> <p>Initialize Position Adjustment : Press the RESET button and the POSITION mode. This function is valid only when RGB signal is input.</p> <ul style="list-style-type: none"> • Valid except for the VOLUME, LANGUAGE and H PHASE. • The RESET button may operate as the mouse control button. Refer to page 4.
MAGNIFY	<p>Set MAGNIFY Mode : Press the MAGNIFY ⊕ button.</p> <p>Move Magnified Area : Run the POSITION in the MAGNIFY mode.</p> <p>Adjust Magnification : Press the MAGNIFY ⊕ / ⊖ button in MAGNIFY mode.</p> <p>Clear MAGNIFY Mode : Press the MAGNIFY ⊖ button.</p> <ul style="list-style-type: none"> • The MAGNIFY mode is cleared by running or setting the AUTO, ASPECT, INPUT SELECT or VIDEO, or by changing the input signal.
FREEZE	<p>Set/Clear FREEZE Mode : Press the FREEZE button. The [] icon is displayed, and the image is frozen, in the FREEZE mode.</p> <ul style="list-style-type: none"> • The FREEZE mode is cleared by running or setting POSITION, VOLUME, MUTE, Automatic Adjustment, BLANK ON/OFF, or MENU ON/OFF, or by changing the input signal. • Do not forget to clear frozen static images.

NOTE • Strong light and obstacles will interfere with operation of the remote control transmitter.

OPERATIONS (continued)

Items indicated by (*) may be used from the control panel.

Table 3. Basic Operation (continued)

Item	Description
VOLUME	Volume Adjustment : Press the VOLUME ⏮ / ⏭ button.
MUTE	Set/Clear Mute Mode : Press the MUTE button. No sound is heard in the MUTE mode.
AUTO	<p>Automatic Adjustment at RGB Input : Press the AUTO button. Horizontal position(H.POSIT), vertical position (V.POSIT),clock phase (H.PHASE), and horizontal size(H.SIZE) are automatically adjusted. Use with the window at maximum size in the application display.</p> <p>Automatic Adjustment at Video Input : Press the AUTO button. A signal type appropriate for the input signal is selected automatically. Valid only when AUTO is set for VIDEO on the menu.</p> <ul style="list-style-type: none"> This operation requires approximately 10 seconds. It may not function correctly with some input signals.
BLANK ON/OFF	Set/Clear Blank Mode: Press the BLANK button. No image is displayed in the Blank mode. The screen color is as set in BLANK on the Image menu.
MENU ON/OFF (*)	<p>Menu Display Start/Stop: Press the MENU button.</p> <ul style="list-style-type: none"> The menu display is terminated automatically after approximately 10 seconds of inactivity.
MENU SELECT	<p>Select Menu Type: Press the MENU SELECT button. Allows the user to select the normal menu or the single menu. Only the selected item is displayed on the single menu, and other items are displayed with the ⏮ and ⏭ buttons as with the normal menu.</p> <ul style="list-style-type: none"> Valid only when the Setup menu is used. Push the MENU SELECT button after selecting items such as "BRIGHTNESS". The MENU SELECT button may operate as the mouse control button. Refer to page 4. <p style="text-align: center;"> Normal menu Single menu </p> <p style="text-align: center;"> </p>
P.IN P. MODE	<p>Select Mode of P.IN P. Display : Press the PinP button.</p> <p>Small → Large → P.IN P. off (→ Small)</p> <ul style="list-style-type: none"> P.IN P. function superimposes a video image over RGB or DVI signals.
KEystone	<p>Set / Clear KEystone Mode (*) : Press the KEystone Ⓢ button.</p> <p>Select KEystone Mode : Press the ⏮ / ⏭ button in the KEystone mode. Vertical ⏮ ↔ ⏭ Horizontal</p> <p>Adjust KEystone : Press the ⏮ / ⏭ button.</p>

OPERATIONS (continued)

Setup Menu

The following adjustments and settings are possible when SETUP is selected at the top of the menu. Part of the Setup menu differs between RGB input and video input. Select an item with the \blacktriangle and \blacktriangledown buttons, and start operation. Use the Single menu to reduce menu size (see Table 3, MENU SELECT).

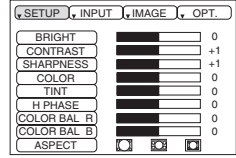
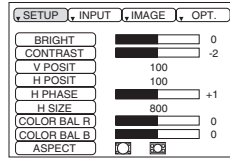

RGB IN 1
RGB IN 2
DVI

VIDEO
S-VIDEO
COMPONENT VIDEO

Table 4. Setup Menu

Item	Description	RGB IN 1 RGB IN 2	DVI	VIDEO S-VIDEO COMPONENT
BRIGHT	Adjustment: Dark \blacktriangleleft \leftrightarrow Light \blacktriangleright	✓	✓	✓
CONTRAST	Adjustment: Weak \blacktriangleleft \leftrightarrow Strong \blacktriangleright	✓	✓	✓
V POSIT	Adjustment: Down \blacktriangleleft \leftrightarrow Up \blacktriangleright	✓	-	-
H POSIT	Adjustment: Left \blacktriangleleft \leftrightarrow Right \blacktriangleright	✓	-	-
H PHASE	Adjustment: Left \blacktriangleleft \leftrightarrow Right \blacktriangleright • Adjust to eliminate flicker.	✓	-	✓
H SIZE	Adjustment: Small \blacktriangleleft \leftrightarrow Large \blacktriangleright • The image may not be displayed correctly if the horizontal size is excessive. In such cases, press the RESET button, and initialize the horizontal size.	✓	-	-
SHARPNESS	Adjustment: Soft \blacktriangleleft \leftrightarrow Clear \blacktriangleright	-	-	✓
COLOR	Adjustment: Light \blacktriangleleft \leftrightarrow Dark \blacktriangleright	-	-	✓
TINT	Adjustment: Red \blacktriangleleft \leftrightarrow Green \blacktriangleright • Valid only when NTSC or NTSC 4.43 signal is received.	-	-	✓
COLOR BAL R	Adjustment: Light \blacktriangleleft \leftrightarrow Dark \blacktriangleright	✓	✓	✓
COLOR BAL B	Adjustment: Light \blacktriangleleft \leftrightarrow Dark \blacktriangleright	✓	✓	✓
ASPECT	Select Image Aspect Ratio : Full [\square] \blacktriangleleft \leftrightarrow \blacktriangleright 16:9 [\square] \blacktriangleleft Select Position of Image: Press the \blacktriangledown button while 16:9 [\square] is selected. Center \rightarrow \blacktriangledown Down \rightarrow \blacktriangledown Up (\rightarrow Center \blacktriangledown)	✓	✓	-
	Select Image Aspect Ratio: 4:3 [\square] \blacktriangleleft \leftrightarrow \blacktriangleright 16:9 [\square] \blacktriangleleft \leftrightarrow \blacktriangleright 4:3 small [\square] Select Position of Image : Press the \blacktriangledown button while 16:9 [\square] / 4:3 small [\square] is selected. Center \rightarrow \blacktriangledown Down \rightarrow \blacktriangledown Up (\rightarrow Center \blacktriangledown) • 4:3 small cannot be selected with the input of 720p or 1080i component. • 4:3 small may not be displayed correctly with some input signals.	-	-	✓

OPERATIONS (continued)

Input Menu

The following functions are available when INPUT is selected on the menu. Select an item with the **▲** and **▼** buttons, and start or stop operation with the **▶** and **◀** buttons. The function indicated (**) are effective on video input mode only, not on RGB input mode, except in the P.IN P. window on RGB input mode.

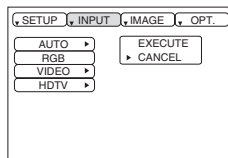

Table 5. Input Menu

Item	Description
AUTO	<p>Automatic Adjustment at RGB Input: Select the EXECUTE with the ▲ button. Horizontal position (H.POSIT), vertical position (V.POSIT), clock phase (H.PHASE), and horizontal size (H.SIZE) are automatically adjusted. Use with the window at maximum size in the application display.</p> <p>Automatic Adjustment at Video Input: Select the EXECUTE with the ▲ button. A signal type appropriate for the input signal is selected automatically when EXECUTE is selected automatically. Valid only when AUTO is set for VIDEO on the menu.</p> <ul style="list-style-type: none"> • This operation requires approximately 10 seconds. It may not function correctly with some input signals. Pressing the AUTO button in this case may correct this problem. • This function is the same as for the AUTO function in Basic operation.
RGB	<p>Displays RGB Input Frequency: Displays the horizontal and vertical sync signal frequencies for RGB input.</p> <ul style="list-style-type: none"> • Valid only at RGB input.
VIDEO (**)	<p>Select Video Signal Type: Select the signal type with the ▲ and ▼ buttons. Select NTSC, PAL, SECAM, NTSC4.43, M-PAL, or N-PAL as appropriate for the input signal. The selection of AUTO enables and executes the function AUTO (Automatic Adjustment at Video Input), except for the N-PAL input.</p> <ul style="list-style-type: none"> • Use this function when the image becomes unstable (eg. the image becomes irregular, or lacks color) at VIDEO/S-VIDEO input. • Automatic Adjustment requires approximately 10 seconds. It may not function correctly with some input signals. Pressing the AUTO button in this case may correct this problem except for the N-PAL input. • For the COMPONENT VIDEO input, this function is not effective and the signal type is distinguished automatically. Refer to the item HDTV of the OPT. Menu for the signal of HDTV.
HDTV	<p>Select HDTV mode: Select the 1035i mode or 1080i mode suitable for the input signal with the ▲ / ▼ button.</p>

OPERATIONS (continued)

Image Menu

The following adjustments and settings are available when IMAGE is selected on the menu. Select an item with the \blacktriangle and \blacktriangledown buttons, and start or stop operation with the \blacktriangleright and \blacktriangleleft buttons.

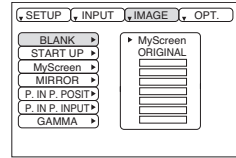

Table 6. Image Menu

Item	Description
BLANK	<p>Select Blank Screen: Select the screen in case of the BLANK mode with the \blacktriangle/\blacktriangledown button. The selected one (MyScreen, ORIGINAL or one colors) is displayed when the BLANK mode is ON.</p> <p>MyScreen is a mode that the customer-customized screen is displayed. This is the blue screen at the factory setting. Refer to the description of MyScreen below.</p> <p>ORIGINAL is a mode that the factory fixed screen is displayed.</p> <ul style="list-style-type: none"> When MyScreen or ORIGINAL is selected, the screen is going to the black after several minutes.
START UP	<p>Select Start Up Screen: Select the screen in case of no signal input with the \blacktriangle/\blacktriangledown button. The selected one (MyScreen, ORIGINAL or TURN OFF) is displayed when no signal is input.</p> <p>My Screen is a mode that the customer-customized screen is displayed. This is the blue screen at the factory setting. Refer to the description of MyScreen below.</p> <p>ORIGINAL is a mode that the factory fixed screen is displayed.</p> <p>TURN OFF displays the blue screen.</p> <ul style="list-style-type: none"> When MyScreen or ORIGINAL is selected, the screen is going to the black after several minutes.
MyScreen	<p>Set MyScreen Mode: Select the EXECUTE with the \blacktriangle button to display the MyScreen menu and set the MyScreen mode for BLANK and START UP functions. ESC clears and closes the menu box.</p> <p>NORM. is default of the MyScreen menu.</p> <p>FREEZE freezes the image and displays the frame to capture. Press the \blacktriangledown button after freeze to go to the MyScreen Capture Position mode. <u>In the MyScreen Capture Position mode</u>, the buttons \blacktriangleleft, \blacktriangleright, \blacktriangle and \blacktriangledown allow to move the frame to capture.</p> <p>After adjusting the position, press the KEYSTONE button to go to the MyScreen Display Size mode.</p> <p>To cancel freezing and return to the NORM. of the MyScreen menu, press the RESET button.</p> <p>In the MyScreen Display Size mode, select the magnification x1, x2 or FULL with the button \blacktriangleleft/\blacktriangleright. After selecting the magnification, press the KEYSTONE button to go to the CAPT. mode and start capturing.</p> <p>To return to the MyScreen Capture Position mode, press the RESET button.</p> <p>CAPT. executes a capturing the image. It requires about 20 seconds. After capturing, the captured image will be displayed for about 10 seconds.</p>
MIRROR	<p>Select Mirror Status: Select mirror status with \blacktriangle / \blacktriangledown button.</p>
P. IN P. POSIT	<p>Select Position of P. in P. Display : Press the \blacktriangle or \blacktriangledown button.</p> <p>\blacksquare \blacktriangle $\blacktriangleleft$$\blacktriangleright$ \blacksquare \blacktriangle $\blacktriangleleft$$\blacktriangleright$ \blacksquare \blacktriangle $\blacktriangleleft$$\blacktriangleright$ \blacksquare</p> <ul style="list-style-type: none"> P.IN P. function superimposes a video image over RGB or DVI signals.
P. IN P. INPUT	<p>Select signal of P. in P. Display : Press the \blacktriangle or \blacktriangledown button.</p> <p>VIDEO \blacktriangle $\blacktriangleleft$$\blacktriangleright$ S-VIDEO \blacktriangle</p>
GAMMA	<p>Select Gamma Mode: Select the gamma mode with the \blacktriangle / \blacktriangledown button.</p> <p>NORMAL \blacktriangle $\blacktriangleleft$$\blacktriangleright$ CINEMA \blacktriangle $\blacktriangleleft$$\blacktriangleright$ DYNAMIC</p>

OPERATIONS (continued)

Options Menu

The following adjustments and settings are available when OPT. is selected on the menu. Select an item with the **▲** and **▼** buttons, and start or stop operation with the **▶** and **◀** buttons.

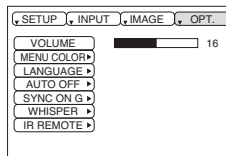
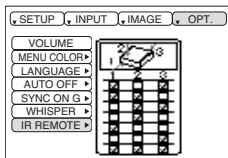

Table 7. Options Menu

Item	Description
VOLUME	Reduce ◀ ↔ ▶ Increase
MENU COLOR	Select Menu Background Color: Select with the ▶ / ◀ button.
LANGUAGE	Select Menu Display Language: Select with the ▲ / ▼ button.
AUTO OFF	Set AUTO OFF: Set 1~99 minutes with the ▲ / ▼ button. The system automatically enters the standby mode when a signal is not received for the set time. Clear AUTO OFF: Select STOP (0 min.) with the ▼ button. When STOP is selected the system does not enter the standby mode even if no signal is received.
SYNC ON G	SYNC ON G Valid: Select TURN ON with the ▲ button. SYNC ON G Invalid: Select TURN OFF with the ▼ button. • May not be displayed correctly with some input signals when SYNC ON G is valid. In such cases, remove the signal connector so that no signal is received, set SYNC ON G to invalid, and reconnect the signal.
WHISPER	Set / Clear WHISPER Mode: Press the ▲ / ▼ button. When the WHISPER is selected, the WHISPER mode is active. In the WHISPER mode, acoustic noise level from the unit is reduced, and brightness level on screen is a little lower.
IR REMOTE	Select Remote Control Sensor: Select the sensors to activate along the menu with the ▲ / ▼ button. Use this function if the remote does not work stably. The ambient light may affect the remote.



: active
 : inactive

OPERATIONS (continued)

No Signal Menu

The same adjustments and settings are available with the Image and Options menus when the MENU button is pressed during display of the “NO INPUT IS DETECTED ON ***” or “SYNC IS OUT OF RANGE ON ***” message while no signal is received. Select an item with the (▲) and (▼) buttons, and start or stop operation with the (▶) and (◀) buttons.

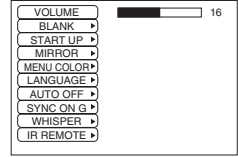



Table 8. No Signal Menu

Item	Description
VOLUME	Reduce (◀) ↔ (▶) Increase <ul style="list-style-type: none"> When this function is used, audio input is automatically switched to video. The audio input can be switched by moving the DISK PAD left and right during the display of the volume adjustment bar. The volume adjustment bar is displayed by pressing VOLUME (▲) / (▼) button.
BLANK	Select Blank Screen: Select the screen in case of the BLANK mode with the (▲)/(▼) button. The selected one (MyScreen, ORIGINAL or one colors) is displayed when the BLANK mode is ON. MyScreen is a mode that the customer-customized screen is displayed. This is the blue screen at the factory setting. Refer to the description of MyScreen below. ORIGINAL is a mode that the factory fixed screen is displayed. <ul style="list-style-type: none"> When MyScreen or ORIGINAL is selected, the screen is going to the black after several minutes.
START UP	Select Start Up Screen: Select the screen in case of no signal input with the (▲)/(▼) button. The selected one (MyScreen, ORIGINAL or TURN OFF) is displayed when no signal is input. My Screen is a mode that the customer-customized screen is displayed. This is the blue screen at the factory setting. Refer to the description of MyScreen below. ORIGINAL is a mode that the factory fixed screen is displayed. TURN OFF displays the blue screen. <ul style="list-style-type: none"> When MyScreen or ORIGINAL is selected, the screen is going to the black after several minutes.
MIRROR	Select Mirror Status: Select the mirror status with the (▲) / (▼) button.
MENU COLOR	Select Menu Background Color: Select the color with the (▶) / (◀) button.
LANGUAGE	Select Menu Display Language: Select the language with the (▲) / (▼) button.
AUTO OFF	Set AUTO OFF: Set 1~99 minutes with the (▲) / (▼) button. The system automatically enters the standby mode when a signal is not received for the set time. Clear AUTO OFF: Select the STOP (0 min.) with the (▼) button. When the STOP is selected the system does not enter the standby mode even if no signal is received.
SYNC ON G	SYNC ON G Valid: Select the TURN ON with the (▲) button. SYNC ON G Invalid: Select the TURN OFF with the (▼) button. <ul style="list-style-type: none"> May not be displayed correctly with some input signals when the SYNC ON G is valid. In such cases, remove the signal connector so that no signal is received, set the SYNC ON G to invalid, and reconnect the signal.
WHISPER	Set / Crear WHISPER Mode: Press the (▲) / (▼) button. When the WHISPER is selected, the WHISPER mode is active. In the WHISPER mode, acoustic noise level from the unit is reduced, and brightness level on screen is a little lower.
IR REMOTE	Select Remote Control Sensor: Select the sensors to activate along the menu with the (▲) / (▼) button. Use this function if the remote does not work stably. The ambient light may affect the remote. <div style="display: flex; align-items: center;"> <div style="border: 1px solid black; padding: 5px; margin-right: 10px;"> <p>VOLUME ▶</p> <p>BLANK ▶</p> <p>START UP ▶</p> <p>MIRROR ▶</p> <p>MENU COLOR ▶</p> <p>LANGUAGE ▶</p> <p>AUTO OFF ▶</p> <p>SYNC ON G ▶</p> <p>WHISPER ▶</p> <p>IR REMOTE ▶</p> </div>  <div style="margin-left: 20px;"> <p><input checked="" type="checkbox"/> : active</p> <p><input type="checkbox"/> : inactive</p> </div> </div>

MAINTENANCE

Lamp



**HIGH VOLTAGE
HIGH TEMPERATURE
HIGH PRESSURE**

Contact your dealer before replacing the lamp.
For the Replacement lamp, see the item “ACCESSORIES” of P.24.

WARNING Before replacing the lamp, switch power OFF, remove the power cord from the power outlet, and wait approximately 45 minutes until the lamp has cooled. The lamp may explode if handled at high temperatures.

WARNING • The projector uses a high-pressure mercury glass lamp. For disposal of used lamp, treat according to the instruction of community authorities.

- Since the lamp is made of glass , do not apply shock to it and do not scratch it.
- Also, do not use old lamp. This could also cause explosion of the lamp.
- Premature lamp failure MAY be caused by an electronic component in the projector and not necessarily the lamp. If unsure contact your local service center.
- If it is probable that the lamp has exploded (explosive sound is heard), disconnect the power plug from the power outlet and ask your dealer to replace lamp. The lamp is covered by front glass, but in rare cases, the reflector and the inside of the projector may be damaged by scattered broken pieces of glass, and broken pieces could cause injury when being handled.
- Do not use the projector with the lamp door removed.

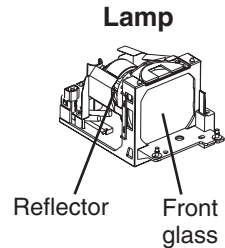

Lamp Life

Projector lamps have a finite life. The image will become darker, and hues will become weaker, after a lamp has been used for a long period of time.

Replace the lamp if the LAMP indicator is red, or the CHANGE THE LAMP message appears when the projector is switched ON. See Table 9 of P.20 and Table 10 of P.21.

NOTE • The LAMP indicator is also red when the lamp unit reaches high temperature. Before replacing the lamp, switch power OFF, wait approximately 20 minutes, and switch power ON again. If the LAMP indicator is still red, replace the lamp.

MAINTENANCE (continued)

Replacing the Lamp

1. Switch the projector OFF, remove the power cord from the power outlet, and wait at least 45 minutes for the unit to cool.
2. Prepare a new lamp.
3. Check that the projector has cooled sufficiently, and gently turn it upside down.
4. Loosen the two screws as shown in the diagram, and remove the lamp door.
5. Loosen the three screws, and gently remove the lamp while holding the grips. Touching the inside of the lamp case may result in uneven coloring.
6. Install the new lamp and tighten the three screws firmly. Also steadily push the opposite side of the screwed lamp into the unit.
7. Replace the lamp door in position and tighten the two screws firmly.
8. Gently turn the projector right-side up.

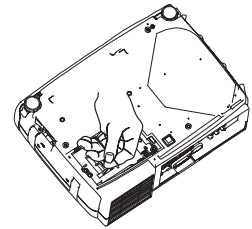
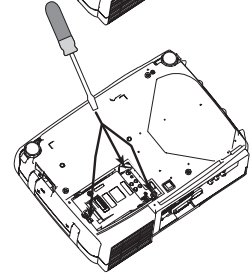
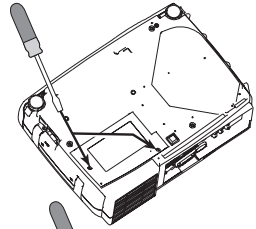

- NOTE**
- Ensure that screws are tightened properly. Screws not tightened fully may result in injury or accidents.
 - Do not use the projector with the lamp door removed.

Resetting the Lamp Timer

Reset the lamp timer after replacing the lamp. When the lamp has been replaced after the LAMP indicator is red, or the CHANGE THE LAMP message is displayed, complete the following operation within ten minutes of switching power ON. The power will be turned off automatically in over 10 minutes.

1. Switch power ON, and press the RESET button, for approximately three seconds. The 'LAMP xxxx hr' message will appear on the lamp timer on the bottom of the screen.
2. Press the MENU button on the remote control transmitter, or the RESET button on the control panel, while the lamp timer is displayed. The 'LAMP xxxx □ → 0 ■ CANCEL' message will then appear.
3. Press the  and select 0, and wait until the timer display is cleared.

- NOTE**
- Do not reset the lamp timer without replacing the lamp. Reset the lamp timer always when replacing the lamp. The message functions will not operate properly if the lamp timer is not reset correctly.

MAINTENANCE (continued)

Air Filter

Cleaning the air Filter

The air filter should be cleaned as described below at intervals of approximately 100 hours.

1. Switch the projector power supply OFF, and remove the power cord from the power outlet.
2. Clean the air filter with a vacuum cleaner.

Replacing the Air Filter

Replace the air filter if contamination cannot be removed, or if it is damaged.

1. Remove the filter cover.
2. Remove the old filter.
3. Set the new filter and the filter cover.



WARNING • Switch power OFF and remove the power cord from the power outlet before beginning maintenance work. Please read the “Product Safety Guide” thoroughly to ensure that maintenance is performed correctly.

- Replace the air filter if contamination cannot be removed, or if it is damaged. Contact your dealer in such case. For the optional air filter, see the item “ACCESSORIES” of P.24.
- Do not use the equipment with the air filter removed.
- When the air filter is clogged with dust etc. the power supply is switched OFF automatically to prevent the temperature rising inside the projector.

Other Maintenance

Maintenance Inside the Equipment

For safety reasons, ensure that the equipment is cleaned and checked by the dealer once every two years. Maintaining the equipment by yourself is dangerous.

Cleaning the Lens

Gently wipe the lens with lens cleaning paper. Do not touch the lens with your hands.

Cleaning the Cabinet and Remote control transmitter

Gently wipe with a soft cloth. If dirt and stains etc. are not easily removed, use a soft cloth dampened with water, or water and a neutral detergent, and wipe dry with a soft, dry cloth.



WARNING • Switch power OFF and remove the power cord from the power outlet before beginning maintenance work. Please read the “Product Safety Guide” thoroughly to ensure that maintenance is performed correctly.

- Do not use detergents or chemicals other than those noted above (e.g. benzene or thinners).
- Do not use cleaning sprays.

NOTE

- Do not rub with hard materials, or tap the equipment.

TROUBLESHOOTING

Service Information

For product information, product assistance, service information, or to order accessories, please call:
In U.S. or Canada : 1-800-328-1371
In other locations, contact your local 3M sales office.

OSD Message

The messages as described below may appear on the screen at power ON. Take the appropriate measures when such messages appear.

Table 9. OSD Message

Message	Contents
CHANGE THE LAMP AFTER REPLACING LAMP, RESET THE LAMP TIME. (*1)	The usage time of lamp will be reaching 2000 hr shortly. (*2) It is recommended to replace the lamp soon. Prepare a new lamp as a replacement.
CHANGE THE LAMP AFTER REPLACING LAMP, RESET THE LAMP TIME. THE POWER WILL TURN OFF AFTER ** hr. (*1)	The usage time of lamp will be reaching 2000 hr shortly. It is recommended to replace the lamp within ** hours. (*2) It might be happened that the lamp is cut off before ** hr by any chance. Power will be switched OFF automatically in ** hours. Replace the lamp as shown in P.17~18 "Lamp". Always reset the lamp timer after replacing the lamp.
CHANGE THE LAMP AFTER REPLACING LAMP, RESET THE LAMP TIME. THE POWER WILL TURN OFF AFTER 0 hr.	The usage time of lamp is about to reach. Power will be switched OFF in a few minutes. (*2) Switch power OFF immediately and replace the lamp as shown in P.17 ~18 "Lamp". Always reset the lamp timer after replacing the lamp.
NO INPUT IS DETECTED ON ***	No input signal found. Check signal input connections and signal sources.
SYNC IS OUT OF RANGE ON ***	The horizontal or vertical frequency of the input signal is not within the specified range. Check the specifications of the equipment and the signal source.

NOTE (*1) This message is cleared automatically after approximately three minutes, and appears every time power is switched ON.

(*2) The unit has a function to turn the power off which will be active when the usage time reaches 2000 hr. However the life of lamp might be much different among lamps, so that it might be happened that a lamp is cut off before the function is active.

TROUBLESHOOTING (continued)

Indicators Message

The POWER indicator, LAMP indicator, and TEMP indicator are lit and blank as follows. Take the appropriate measures.

Table 10. Indicators Message

POWER indicator	LAMP indicator	TEMP indicator	Contents
Lights orange	Turns off	Turns off	The Standby mode has been set.
Blinks green	Turns off	Turns off	Warming up. Please wait.
Lights green	Turns off	Turns off	ON. Normal operation possible.
Blinks orange	Turns off	Turns off	Cooling. Please wait.
Blinks red	-	-	Cooling. Please wait. The error is found. Take the appropriate measures when the POWER indicator ceases blinking
Blinks /Lights red	Lights red	Turns off	Lamp is not lit. The interior of the equipment may be too hot. Switch power OFF, wait 20 minutes until the equipment cools, and check whether the ventilation openings are blocked, whether the air filter is dirty, or whether the ambient temperature exceeds 35 °C. And switch power ON again. Replace the lamp if the same problem occurs.
Blinks /Lights red	Blinks red	Turns off	Lamp or lamp door is not found, or hasn't been fitted in correctly. Switch power OFF, and wait for 45 minutes until the equipment cools. Check fitting of the lamp and lamp door, and switch power ON again. Contact your dealer if the same problem occurs again.
Blinks /Lights red	Turns off	Blinks red	The cooling fan is not operating. Switch power OFF, and wait for 20 minutes until the equipment cools. Check for foreign matters in the fan, and switch power ON again. Contact your dealer if the same problem occurs again.
Blinks /Lights red	Turns off	Lights red	The interior of the equipment is too hot. Switch power OFF, and wait for 20 minutes until the equipment cools. Check whether the ventilation openings are blocked, whether the air filter is dirty, or whether the ambient temperature exceeds 35 °C. Then switch power ON again. Contact your dealer if the same problem occurs again.
Lights green	Blinks red	Blinks red	The interior of the equipment is too cool. Check whether the ambient temperature is below 0°C. Contact your dealer if the same problem occurs when the ambient temperature is 0~35°C.

NOTE When the internal temperature becomes excessive power is switched OFF automatically for safety reasons, and the indicator is extinguished. Set the power switch to [O] and wait for 20 minutes until the equipment has cooled sufficiently.

TROUBLESHOOTING (continued)

Symptom

Before requesting repair, check in accordance with the following chart. If the situation cannot be corrected, then contact your dealer.

Table 11. Symptom

Symptom	Possible cause	Remedy	Page
The power is not turned on.	The main power switch is not turned on.	Turn on the main power switch.	8,9
	The power cord is disconnected.	Plug the power cord into an AC power outlet.	
No video or audio.	The input is not correctly set.	Use the projector or remote control transmitter to set.	10
	No signal input.	Connect correctly.	7,8
Video is present but no audio.	The projector is not correctly connected.	Connect correctly.	7,8
	The volume is set to minimum.	Press VOLUME (◀) on the remote control or display the menu screen and adjust the volume.	11,15
	Mute is turned on.	Press the MUTE (⊘) button.	11
Audio is present but no video.	The projector is not correctly connected.	Connect correctly.	7,8
	The brightness adjustment knob is rotated fully clockwise.	Select BRIGHT with the MENU button and the press the (▶) button.	12
	The lens cap is still attached.	Remove the lens cap.	9
Colors are pale and color matching is poor.	Color density and color matching are not correctly adjusted.	Adjust the video.	12
Images are dark.	Brightness and contrast are not correctly adjusted.	Adjust the video.	12
	The lamp is nearing the end of its service life.	Replace with a new lamp.	17
	WHISPER mode is set.	Clear WHISPER mode.	15
Video is blurred.	Focus or H PHASE is out of adjustment.	Adjust the focus or H PHASE.	9,12

SPECIFICATIONS

Table 12. Specifications

Item		Specification	
Product name		Liquid crystal projector	
Liquid crystal panel	Panel size	2.3 cm (0.9 type)	
	Drive system	TFT active matrix	
	Pixels	786,432 pixels (1024 horizontal x 768 vertical)	
Lens		Zoom lens F=1.7 ~ 2.1 f=36.8 ~ 47.8 mm	
Lamp		250 W UHB	
Speaker		1.0W+1.0W (stereo)	
Power supply		AC100 ~ 120V, 4.5A / AC220 ~ 240V, 1.9A	
Power consumption		410W	
Temperature range		0 ~ 35°C (Operating)	
Size		360 (W) x 106 (H) x 256.5 (D) mm	
Weight (mass)		4.5 kg	
RGB signal input	RGB IN	1	Video: Analog 0.7Vp-p, 75Ω terminator (positive) H/V. sync.: TTL level (positive/negative) Composite sync.: TTL level D-sub 15-pin shrink jack
		2	
	DVI		TMDS, DC: 150~1200 mV / AC: 1.56 Vp-p TTL Level (Positive/Negative)
	AUDIO IN	RGB1	200mVrms, 50 kΩ (max. 3.0Vp-p) Stereo mini jack
DVI			
RGB2			
Video signal input	VIDEO IN		1.0Vp-p, 75Ω terminator RCA jack
	S-VIDEO IN		Brightness signal: 1.0Vp-p, 75Ω terminator Color signal: 0.286Vp-p (NTSC, burst signal), 75Ω terminator 0.300Vp-p (PAL/SECAM, burst signal), 75Ω terminator Mini DIN 4-pin jack
	COMPONENT VIDEO	Y	1.0 Vp-p, 75 Ω Terminator (Positive)
		CB/CR	0.7 Vp-p, 75 Ω Terminator (Positive)
		PB/PR	0.7 Vp-p, 75 Ω Terminator (Positive)
	AUDIO IN	L	200mVrms, 50 kΩ (max. 3.0Vp-p) RCA jack
R			
Signal output	RGB OUT		Video: Analog 0.7Vp-p, 75Ω output impedance (positive) H/V. sync.: TTL level (positive/negative) Composite sync.: TTL level D-sub 15-pin shrink jack
	AUDIO OUT		200mVrms, output impedance 1 kΩ (max. 3.0Vp-p) Stereo mini jack
Control functions	CONTROL		D-sub 15-pin shrink plug
	USB		USB jack (B type)

NOTE • This specifications are subject to change without notice.

ACCESSORIES

Accessories.....	Part Number
UHB Lamp, 250W	78-6969-9547-7
Air Filter	78-8118-8969-6
Power Cord (US)	78-8118-8102-4
Power Cord (UK)	78-8118-8101-6
Power Cord (Europe)	78-8118-8103-2
VGA Cable	78-8118-8708-8
RCA Component Cable	78-8118-8843-3
RCA Video/Audio Cable	78-8118-3234-0
S-Video Cable	78-8118-3238-1
Stereo Mini-Cable	78-8118-8846-6
Mouse Cable (PS/2)	78-8118-8105-7
Mouse Cable (Serial)	78-8118-8107-3
Remote Control Transmitter	78-8118-9186-6

Not Included with Basic Packet.....	Part Number
Ceiling mount	78-6969-9696-2
Adjustable Height Suspension	78-6969-9714-3
Shipping Case	78-6969-8925-6
Soft side case with shoulder strap	78-6969-9203-7
Soft rolling luggage case	78-6969-8926-4
Mouse Cable (ADB)	78-8118-8106-5
Mouse Cable (USB)	78-8118-8186-7
RS-232C Control Cable	78-8118-3312-4
Ultra value warranty X65 (US only)	78-6969-9707-7
Mac Adapter	78-8118-3308-2

How to Order

Please order these parts through your dealer, or contact 3M Customer Service at the following number :

In U.S. or Canada : **1-800-328-1371**

In other locations, contact your local 3M sales office.